

N-Channel 65-V_(D-S) SGT MOSFET

PRODUCT SUMMARY		
B _{VDSS} (V)	R _{DS(on)} (mΩ)(MAX)	I _D (A)
65	4.7@V _{GS} =10V	115

TO220 Pin Configuration

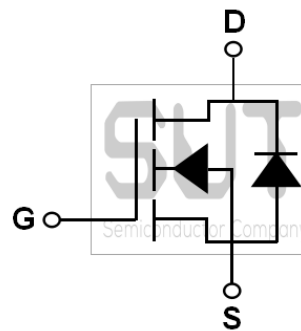

ABSOLUTE MAXIMUM RATINGS(T_C=25°C UNLESS OTHERWISE NOTED)

Parameter	Symbol	Rating	Units
Drain-Source Voltage	V _{DS}	65	V
Gate-Source Voltage	V _{GS}	+20/-12	V
Drain Current-Continuous (T _C =25°C)	I _D	115	A
Drain Current-Continuous (T _C =100°C)		72	A
Drain Current-Pulsed ¹	I _{DM}	460	A
Single Pulse Avalanche Energy ²	EAS	174	mJ
Single Pulse Avalanche Current ²	IAS	59	A
Power Dissipation (T _C =25°C)	P _D	160	W
Power Dissipation-Derate above 25°C		1.28	W/°C
Storage Temperature Range	T _{STG}	-50 to 150	°C
Operating Junction Temperature Range	T _J	-50 to 150	°C

THERMAL CHARACTERISTICS

Parameter	Symbol	Typ.	Max.	Unit
Thermal Resistance Junction to ambient	R _{θJA}	---	62	°C/W
Thermal Resistance Junction to Case	R _{θJC}	---	0.78	°C/W

ELECTRICAL CHARACTERISTICS (T _J =25°C UNLESS OTHERWISE NOTED)						
Parameter	Symbol	Test Condition	Min.	Typ.	Max.	Unit
Off Characteristics						
Drain-Source Breakdown Voltage	BV _{DSS}	V _{GS} =0V, I _D =250uA	65	---	---	V
BV _{DSS} Temperature Coefficient	ΔBV _{DSS} /ΔT _J	Reference to 25°C, I _D =1mA	---	0.02	---	V/°C
Drain-Source Leakage Current	I _{DSS}	V _{GS} =0V, V _{DS} =60V, T _J =25°C	---	---	1	uA
		V _{GS} =0V, V _{DS} =48V, T _J =85°C	---	---	10	uA
Gate-Source Leakage Current	I _{GSS}	V _{GS} =20V, V _{DS} =0V	---	---	100	nA
On Characteristics						
Static Drain-Source On-Resistance	R _{DS(ON)}	V _{GS} =10V, I _D =15A	---	3.9	4.7	mΩ
		V _{GS} =4.5V, I _D =8A	---	6.2	8	mΩ
Gate Threshold Voltage	V _{GS(th)}	V _{GS} =V _{DS} , I _D =250uA	1.0	1.5	2.5	V
V _{GS(th)} Temperature Coefficient	ΔV _{GS(th)}		---	-5.1	---	mV/°C
Forward Transconductance	g _{fs}	V _{DS} =10V, I _D =3A	---	12	---	S
Dynamic and Switching Characteristics						
Total Gate Charge ^{3, 4}	Q _g	V _{GS} =10V, V _{DS} =48V, I _D =5A	---	54	108	nC
Gate-Source Charge ^{3, 4}	Q _{gs}		---	5.2	10.4	
Gate-Drain Charge ^{3, 4}	Q _{gd}		---	16.1	32.2	
Turn-On Delay Time ^{3, 4}	T _{d(on)}	V _{GS} =10V, V _{DD} =30V, R _G =6Ω, I _D =1A	---	10.6	21	ns
Rise Time ^{3, 4}	T _r		---	16.5	33	
Turn-Off Delay Time ^{3, 4}	T _{d(off)}		---	48	96	
Fall Time ^{3, 4}	T _f		---	78	150	
Input Capacitance	C _{iss}	V _{GS} =0V, V _{DS} =30V, F=1MHz	---	2940	5900	pF
Output Capacitance	C _{oss}		---	850	1700	
Reverse Transfer Capacitance	C _{rss}		---	15	30	
Gate resistance	R _g	V _{GS} =0V, V _{DS} =0V, F=1MHz	---	1.24	---	Ω
Drain-Source Diode Characteristics and Maximum Ratings						
Continuous Source Current	I _S	V _G =V _D =0V, Force Current	---	---	115	A
Pulsed Source Current	I _{SM}		---	---	230	A
Diode Forward Voltage	V _{SD}	V _{GS} =0V, I _S =1A, T _J =25°C	---	---	1.0	V

Note :

1. Repetitive Rating : Pulsed width limited by maximum junction temperature.
2. V_{GS}=10V, V_{DD}=25V, L=0.1mH, I_{AS}=59A, R_G=25Ω, Starting T_J=25°C.
3. The data tested by pulsed, pulse width ≤ 300us, duty cycle ≤ 2%.
4. Essentially independent of operating temperature.

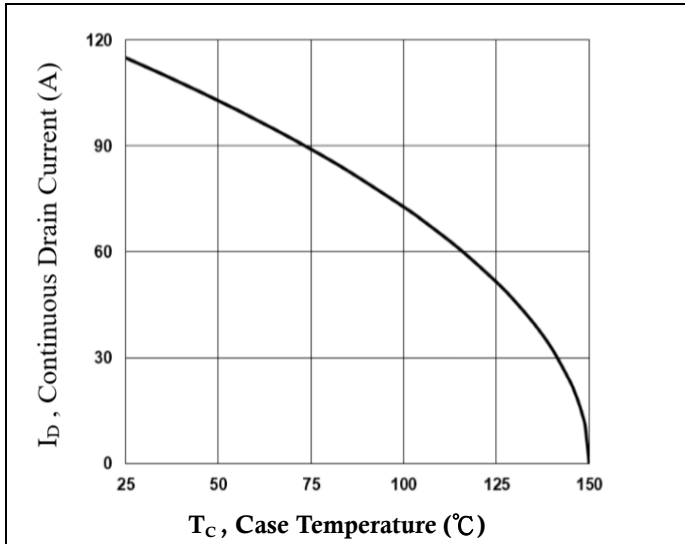

Continuous Drain Current vs. T_C

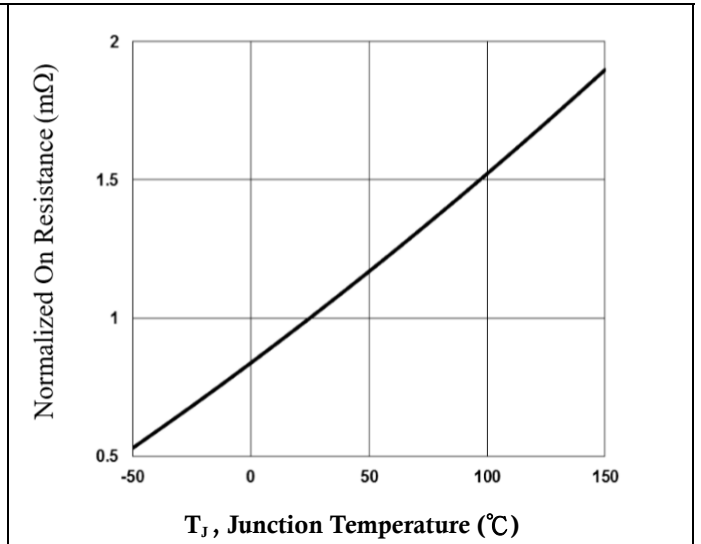

Normalized $R_{DS(ON)}$ vs. T_J

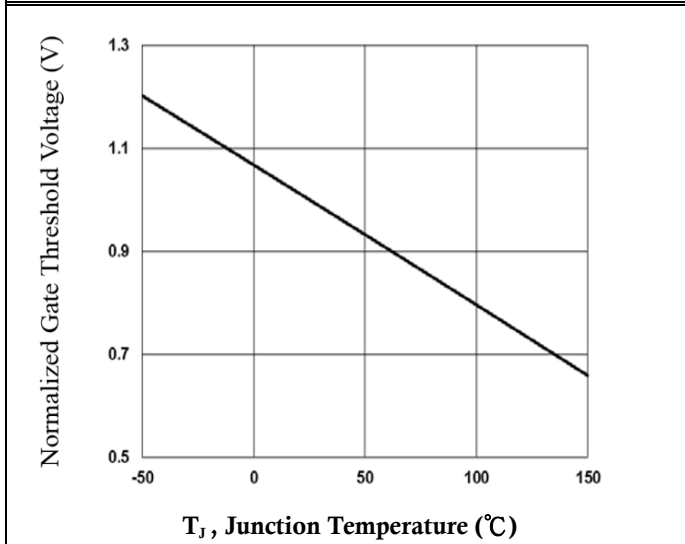

Normalized V_{th} vs. T_J

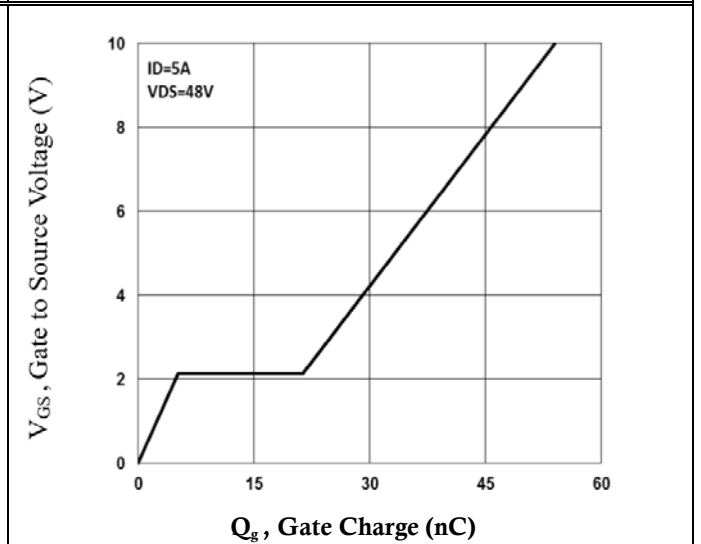

Gate Charge Characteristics

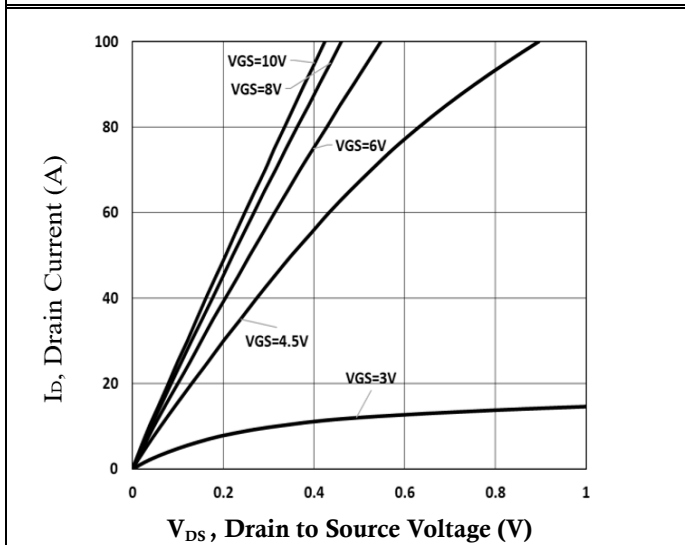

Typical Output Characteristics

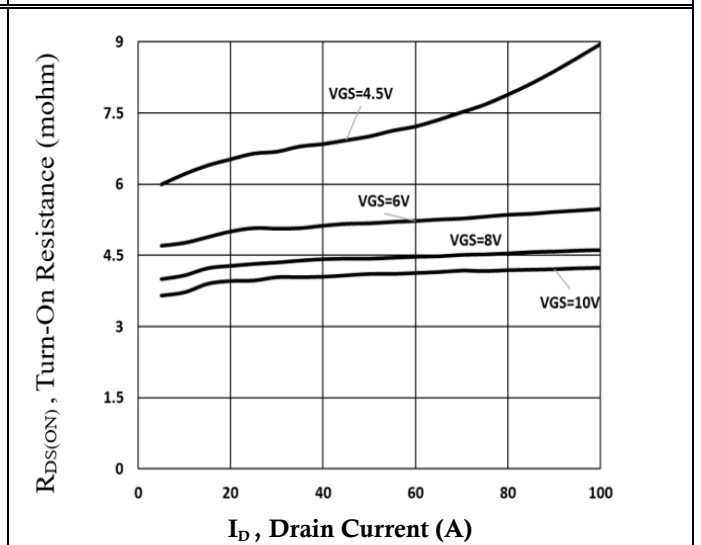

Turn-On Resistance vs. I_D

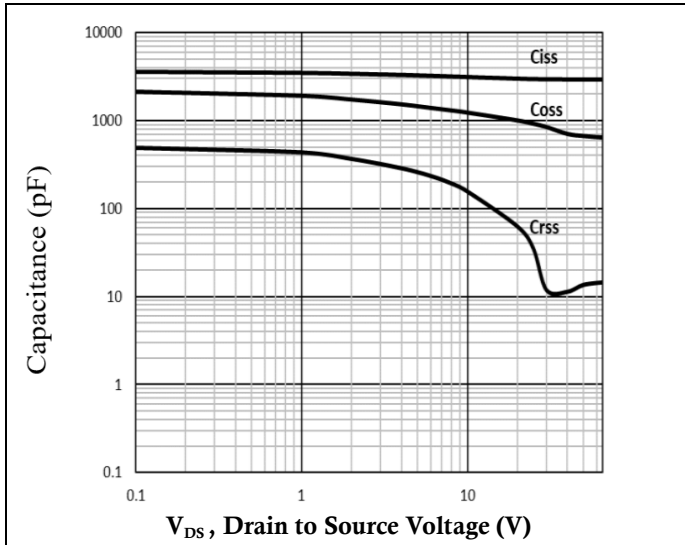

Capacitance Characteristics

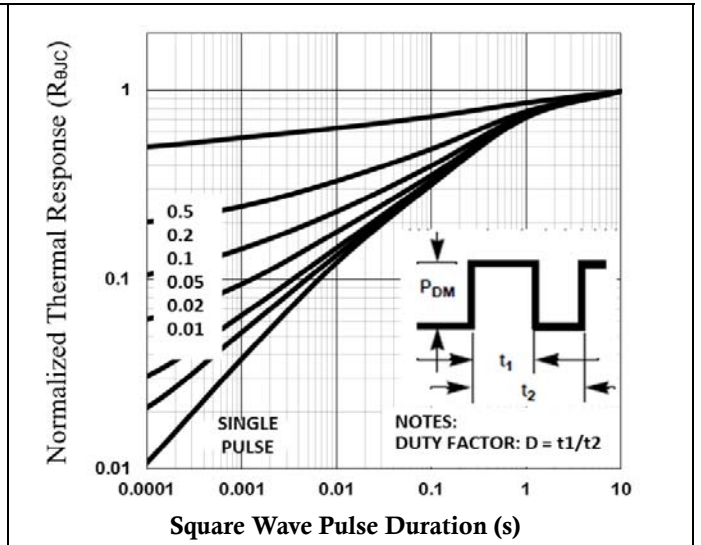

Normalized Transient Impedance

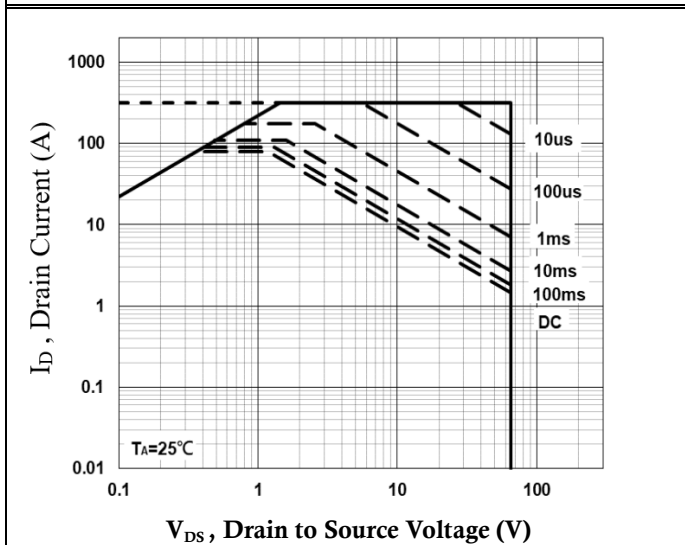

Maximum Safe Operation Area

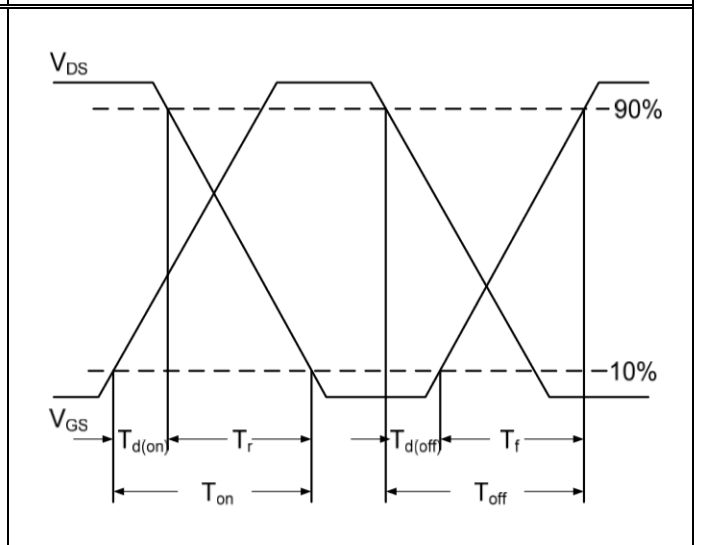

Switching Time Waveform

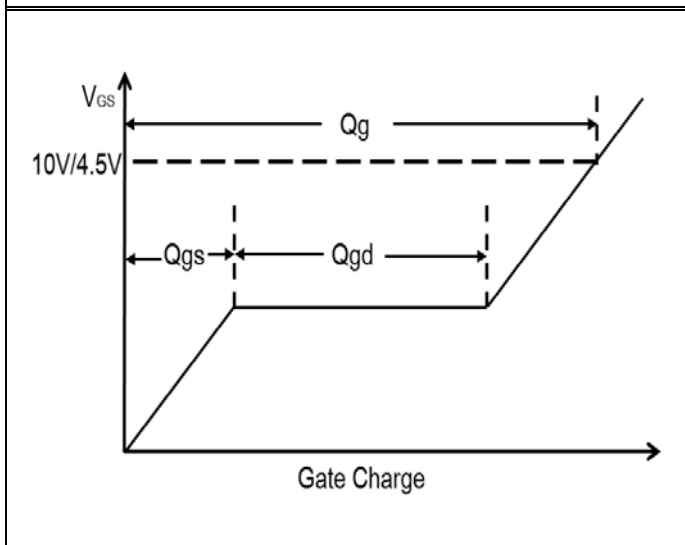

Gate Charge Waveform

TO220 PACKAGE INFORMATION

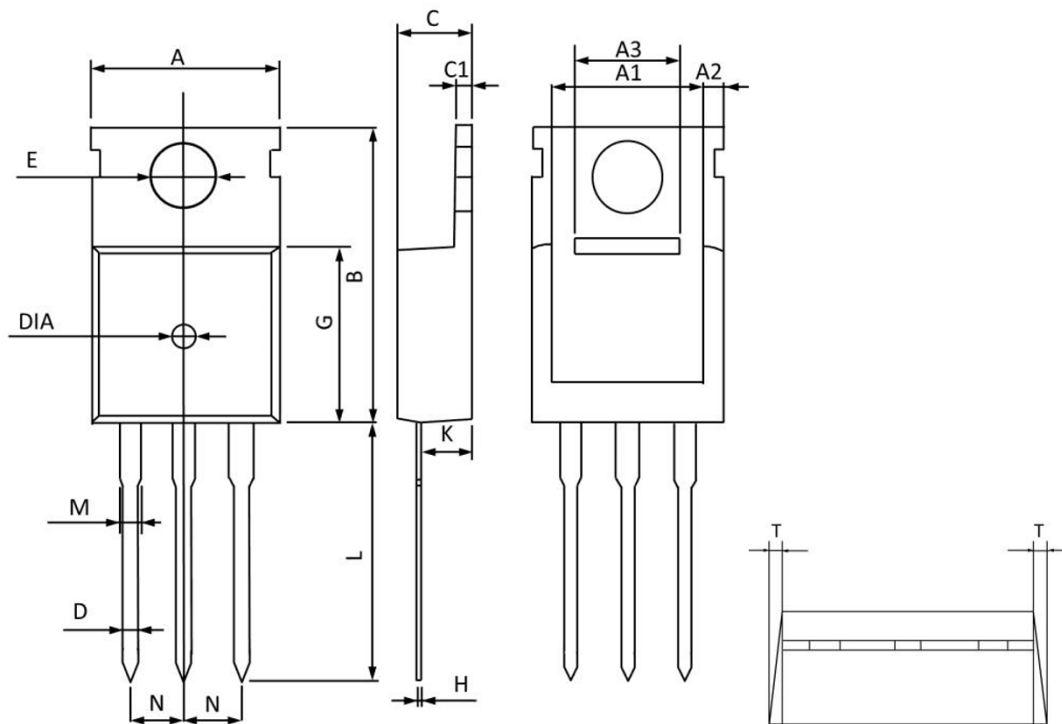

Symbol	Dimensions In Millimeters		Dimensions In Inches	
	MAX	MIN	MAX	MIN
A	10.300	9.700	0.406	0.382
A1	8.840	8.440	0.348	0.332
A2	1.250	1.050	0.049	0.041
A3	5.300	5.100	0.209	0.201
B	16.200	15.400	0.638	0.606
C	4.680	4.280	0.184	0.169
C1	1.500	1.100	0.059	0.043
D	1.000	0.600	0.039	0.024
E	3.800	3.400	0.150	0.134
G	9.300	8.700	0.366	0.343
H	0.600	0.400	0.024	0.016
K	2.700	2.100	0.106	0.083
L	13.600	12.800	0.535	0.504
M	1.500	1.100	0.059	0.043
N	2.590	2.490	0.102	0.098
T	W0.350		W0.014	
DIA	Ø1.500(TYP)	Deep0.200(TYP)	Ø0.059(TYP)	Deep0.008(TYP)